

Shark **CarpetXpert**

**EX150
SERIES**

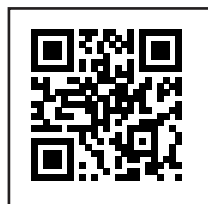

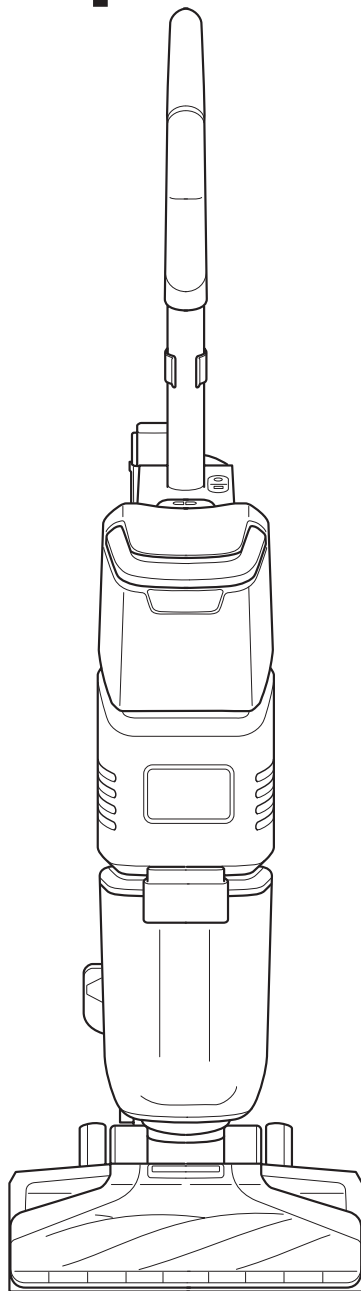

To view **HOW-TO VIDEOS**
scan QR Code located on
top of CarpetXpert Tank.



TIP: You can find the model and serial numbers on the QR code label located on the back of your unit.

REGISTER YOUR PURCHASE

TO BENEFIT FROM YOUR PRODUCT'S EXTENDED GUARANTEE, SIMPLY REGISTER YOUR PURCHASE AT:

-  sharkclean.co.uk/register-guarantee
-  +44 (0)800 862 0453
-  Scan QR code using mobile device

Please note, products purchased directly from Shark are automatically registered.

Benefits of registering your product and creating an account:

- Get easier, faster product support and access to guarantee information
- Access troubleshooting and product care instructions
- Be among the first to know about exclusive product promotions

RECORD THIS INFORMATION

Model Number: _____

Serial Number: _____

Date Code: _____

Date of Purchase (Keep Receipt): _____

Store of Purchase: _____

TECHNICAL SPECIFICATIONS

Voltage: 220 - 240V

Watts: 960W

PLEASE READ CAREFULLY AND KEEP FOR FUTURE REFERENCE.

This instruction manual is designed to help you get a complete understanding of your new Shark CarpetXpert.

If you have any questions, please call the customer service line on +44 (0)800 862 0453.



CONTENTS

Important Safety Instructions.....4

What's Included.....6

Assembly.....7

Hose Assembly.....8

Cleaning Solution and Tanks.....9

Shark Cleaning Solution.....9

Filling the Tank.....9

How to Use CarpetXpert.....10

Cleaning with CarpetXpert.....10

Cleaning with the Hand Tool.....10

How to use the Handtool.....11

Maintenance.....12

Cleaning the Dirty Water Tank.....12

Cleaning the Brush-Roll.....12

Cleaning the Hand Tools.....13

Unclogging the System.....13

Cleaning & Drying Guide.....14

Best Practice Floor Nozzle Use.....14

Best Practice Stain Cleaning.....14

Best Practice for Faster Dry Time.....14

Guarantee.....15



This marking indicates that this product should not be disposed with other household wastes. To prevent possible harm to the environment or human health from uncontrolled waste disposal, recycle it responsibly to promote the sustainable reuse of material sources. To return your used device, please use the return and collection systems or contact the retailer where this product was purchased. They can take this product for environmentally safe recycling.

IMPORTANT SAFETY INSTRUCTIONS

FOR HOUSEHOLD USE ONLY • PLEASE READ ALL INSTRUCTIONS BEFORE USING THIS CARPET EXTRACTOR.

To reduce the risk of shock and unintended operation, turn off power before servicing. If the supply cord is damaged, it must be replaced by the manufacturer, its service agent, or similarly qualified persons in order to avoid a hazard.

⚠ WARNING

REDUCE THE RISK OF FIRE, ELECTRIC SHOCK, INJURY, OR PROPERTY DAMAGE:

1. If the power cord plug does not fit fully into the socket, contact a qualified electrician. **DO NOT** force into socket or try to modify to fit.
2. To reduce the risk of shock and unintended operation, unplug before servicing.
3. This carpet cleaner consists of a motorised nozzle, main body, pole, handle, hose, and hand tools. These components contain electrical connections, electrical wiring, and moving parts that potentially present risk to the user.
4. Before each use, carefully inspect all parts for any damage. If a part is damaged, discontinue use.
5. Use only identical Shark® replacement parts.
6. **DO NOT** use the carpet cleaner for any purpose other than those described in this booklet.
7. **DO NOT** immerse or spray water on the body of the carpet cleaner. To clean the surface, wipe with a dry cloth.
8. Keep the carpet cleaner's cord out of reach of children.
9. **DO NOT** allow the appliance to be used by children. **DO NOT** allow to be used as a toy. Close supervision is necessary when used near children. Cleaning and user maintenance must not be done by children.
10. This appliance can be used by persons with reduced physical, sensory or mental capabilities or lack of experience or knowledge if they have been given supervision or instruction concerning use of the appliance in a safe way and understand the hazards involved.
11. **DO NOT** handle plug or carpet cleaner with wet hands.
12. **DO NOT** use without the dirty water tank, clean solution tank, filter, brushroll, and brushroll cover in place.
13. Only use Shark® branded filters and accessories.
14. **DO NOT** put any objects into nozzle opening. **DO NOT** use with any opening blocked; keep free of dust, lint, hair, and anything that may reduce airflow.
15. **DO NOT** use if nozzle airflow is restricted. If the air paths or the motorised floor nozzle become blocked, turn the carpet cleaner off. Remove all obstructions before you turn on the unit again. Keep nozzle and all carpet cleaner openings away from hair, face, fingers, uncovered feet, or loose clothing.
16. **DO NOT** use if carpet cleaner is not working as it should, or has been dropped, damaged, left outdoors, or dropped into water.
17. Use extra care when cleaning on stairs.
18. **DO NOT** leave the carpet cleaner unattended while plugged in.
19. When using on any surface, always keep the carpet cleaner moving to avoid damaging the surface (e.g., carpet fibres).
20. **DO NOT** place carpet cleaner on unstable surfaces such as chairs or tables. The surrounding area may be slippery and present a risk of injury.
21. **DO NOT** use to pick up:
 - a) Large objects.
 - b) Hard or sharp objects (glass, nails, screws, or coins).
 - c) Large quantities of dust (e.g., drywall dust).
 - d) Smoking or burning objects (hot coals, cigarette butts, or matches).
 - e) Flammable or combustible materials (lighter fluid, petrol, or kerosene).
 - f) Toxic materials (chlorine bleach, ammonia, or drain cleaner).
22. **DO NOT** use in the following areas:
 - a) Poorly lit areas.
 - b) Outdoor areas.
 - c) Spaces that are enclosed and may contain explosive or toxic fumes or vapours (lighter fluid, petrol, kerosene, paint, paint thinners, mothproofing substances, or flammable dust).
23. The plug must be removed from the socket-outlet before any adjustment, cleaning or maintenance of the appliance.
24. During cleaning or routine maintenance, **DO NOT** cut anything other than hair, fibres, or string wrapped around the brushroll.
25. **DO NOT** modify or attempt to repair the carpet cleaner yourself. **DO NOT** use the carpet cleaner if it has been modified or damaged.
26. Turn off all controls before unplugging.
27. To reduce the risk of fire or electric shock due to internal component damage, use only Shark® cleaning solution. See the Cleaning Fluid section of this Instruction Booklet.
28. **DO NOT** pull or carry by cord, use cord as a handle, close a door on cord, or pull cord around sharp edges or corners. **DO NOT** run appliance over cord. Keep cord away from heated surfaces.
29. **DO NOT** unplug by pulling on cord. To unplug, grasp the plug, not the cord.
30. Use indoors only.
31. **DO NOT** use carpet cleaner on hard floors or wool as it may damage your floor. To avoid damage to flooring and to avoid potential slip hazard, after use: (a) move to a hard sealed surface (avoid unsealed, wood and laminate) and (b) place unit on absorbent material like a towel to soak up any liquid.
32. **DO NOT** fill solution tanks while installed on the appliance. Remove before filling.
33. **DO NOT** use vinegar in any tanks.
34. The areas around where you are cleaning may become wet, use care to avoid slipping and falling.
35. Use care when removing and reattaching the hand tool to the crevice tool to avoid accidental activation of the cleaning solution. **DO NOT** spray solution on your skin or in your eyes.
36. Improper connection of the equipment grounding conductor can result in a risk of electric shock. Check with a qualified electrician or service person if you are in doubt as to whether the socket is properly grounded. **DO NOT** modify the plug provided with the appliance. If the plug will not fit the socket, have a proper socket installed by a qualified electrician.
37. This appliance is for use on a nominal V circuit and has a grounding attachment plug that looks like the plug illustrated below. Make sure that the appliance is connected to a socket having the same configuration as the plug. No adaptor should be used with this appliance.
38. **DO NOT** immerse. To reduce risk of electric shock, use only on carpet moistened by cleaning.

39. **DO NOT** run over edges of area rugs.
40. Stalling the brush roll may result in premature belt failure.
41. Avoid repeated strokes over the same area, to help prevent damage to Berber/ Loop Pile carpets.
42. Check manufacturer's tag prior to cleaning area rugs for any specific cleaning guidelines. We **DO NOT** recommend deep cleaning delicate rugs (including silk, antique, or area rugs that **DO NOT** have a manufacturer's tag).
43. **DO NOT** store unit where temperatures reach freezing levels to avoid damaging internal parts.
44. **FIRST AID** Keep out of reach of children. Causes skin and serious eye irritation. **IF IN EYES**, rinse continuously with water for minutes. Remove contact lenses if present and easy to do so. Continue rinsing. **IF ON SKIN**, wash with soap and water. If skin and eye irritation persists, seek medical attention. Please recycle container. Dispose of contents/container with a licensed waste disposal site in accordance with the requirements of the local waste disposal authority. **DO NOT** dispose in drains or watercourses in concentrate form.

SAVE THESE INSTRUCTIONS

WHAT'S INCLUDED

What's Included: Shark® CarpetXpert, 355ml. Shark Deep Clean Pro Solution, 473ml. Shark OXY Multiplier, Hose-Cleaning Tool, Hand Tool(s)

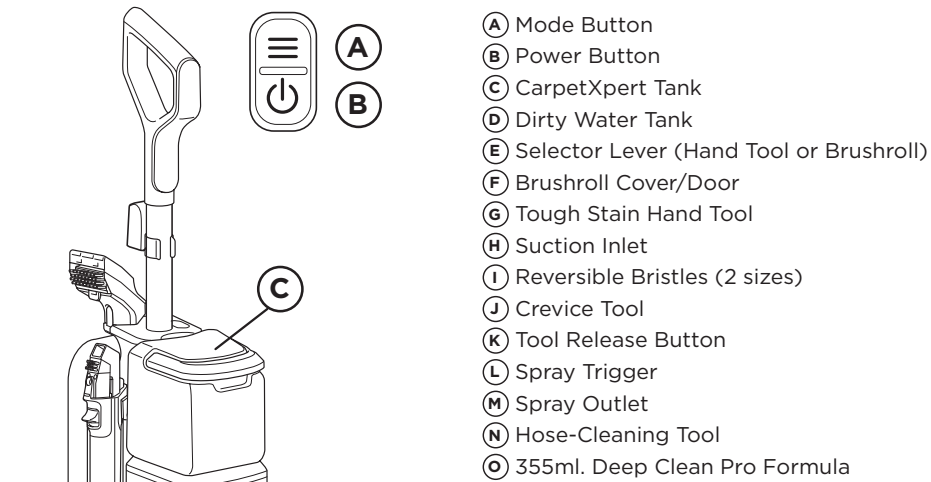

- (A) Mode Button
- (B) Power Button
- (C) CarpetXpert Tank
- (D) Dirty Water Tank
- (E) Selector Lever (Hand Tool or Brushroll)
- (F) Brushroll Cover/Door
- (G) Tough Stain Hand Tool
- (H) Suction Inlet
- (I) Reversible Bristles (2 sizes)
- (J) Crevice Tool
- (K) Tool Release Button
- (L) Spray Trigger
- (M) Spray Outlet
- (N) Hose-Cleaning Tool
- (O) 355ml. Deep Clean Pro Formula

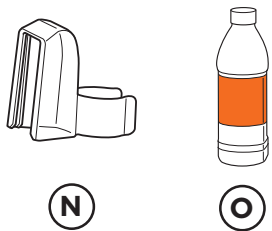
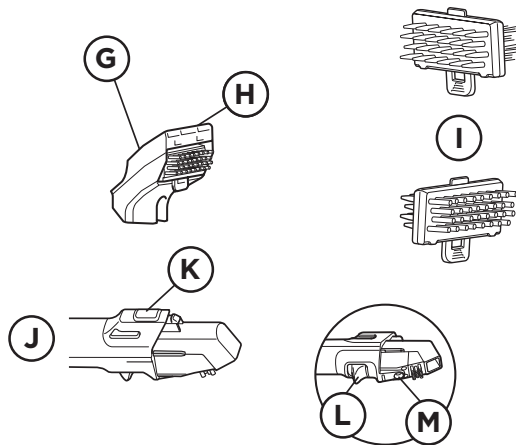

ASSEMBLY

1. Insert pole into the top of unit until it clicks into place (**fig. 1**).
2. Store the hose-cleaning tool by clipping it onto the pole (**fig. 2**).
3. Attach chosen hand tool to crevice tool (**fig. 3**).
4. Be sure the rubber seal is seated in place under the dirty water tank (**fig. 4**).
5. Install the dirty water tank by placing the bottom on the nozzle lip then tilting it forward until it clicks into place (**fig. 5**).

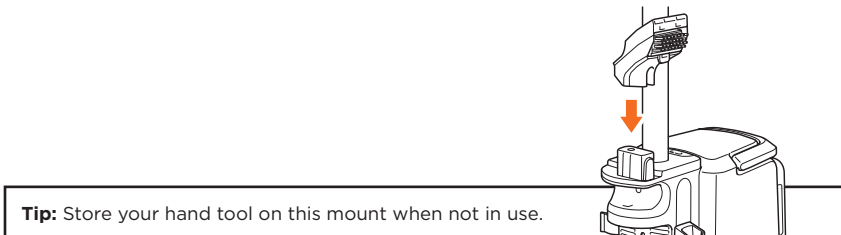
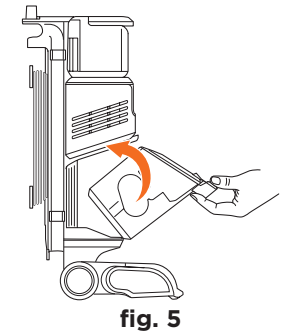
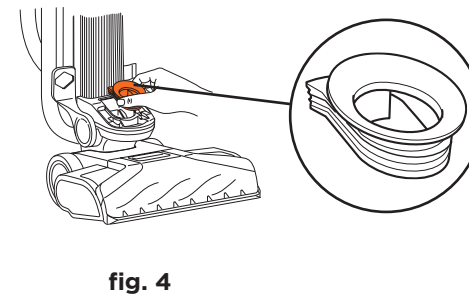
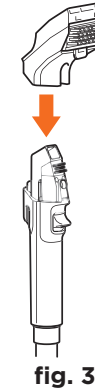
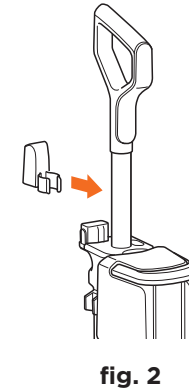
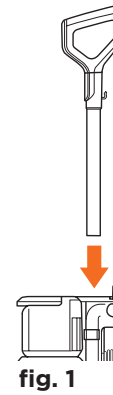

HOSE ASSEMBLY

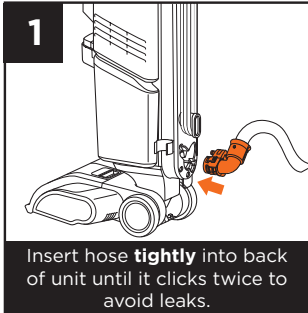

TIP: Wrap hose tightly, leaving no slack

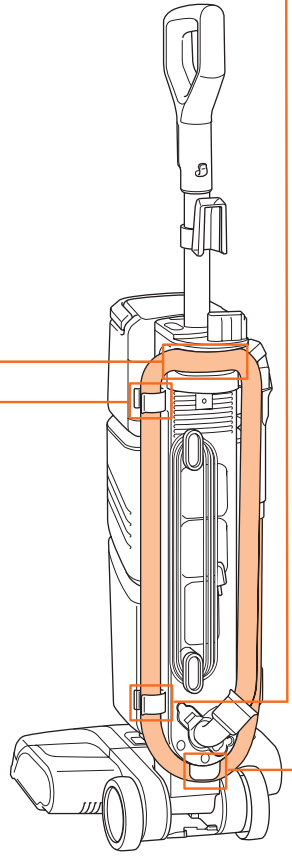
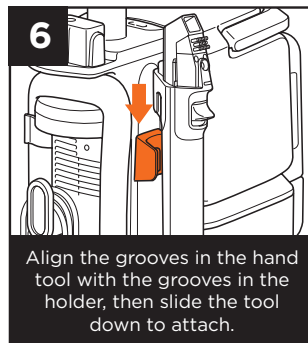
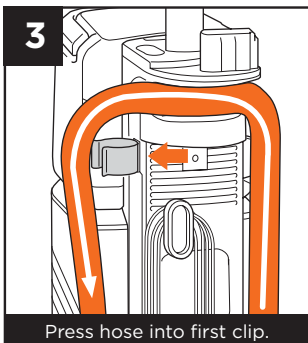
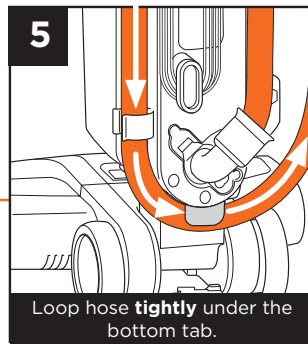
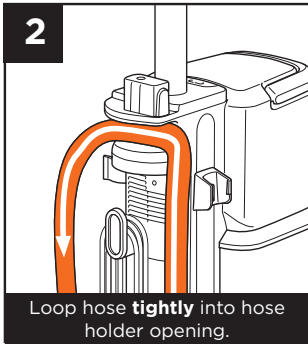
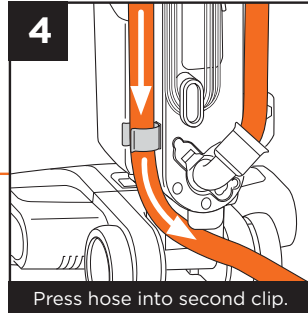

SHARK® CLEANING SOLUTIONS AND TANKS

SHARK CLEANING SOLUTION

Use **ONLY** Shark branded cleaning solutions. Taking care to use the CarpetXpert formula in the correct tanks. Unit is not compatible with other solutions or cleaners.



Shark Deep Clean Pro
For deep-cleaning carpets with the brushroll

FILLING THE TANKS

Filling the CarpetXpert Tank (top clear tank)

1. Lift the CarpetXpert Tank by the handle to detach it, then remove the cap.
2. Add warm water to the tank up to the WATER fill line. Do not use water hotter than 60°C (140°F).
3. Add Shark Deep Clean Pro up to the CONCENTRATE fill line.
4. Reattach cap, then reinstall the CarpetXpert Tank, hearing a 'click' once installed properly.

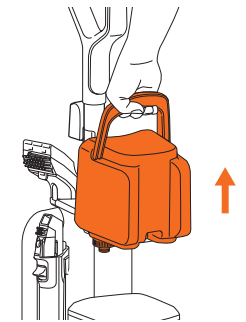

To order refills of Shark® Deep Clean Pro scan the QR code.

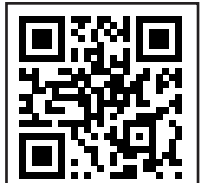

DEEP CLEANING with the brushroll:

Important: Vacuum with traditional vacuum cleaner first.

1. Move the selector lever to **UP** position to engage the floor nozzle.
2. Gently step on the base and tilt the handle back.
3. Press power button; unit will enter 'Deep Clean' Mode.
4. Move unit forward slowly; it will automatically dispense water and Deep Clean Pro cleaning solution.
5. On the backpass, the unit will use suction to extract liquid and aid the drying process.
6. Repeat steps 4 and 5.
7. Once deep clean is complete, press the Mode button, to activate Dry Only mode. Repeat passes over the entire cleaning area multiple times to help to reduce dry time.

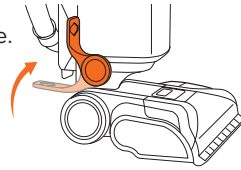

fig. 1

Note: Dry time can be impacted by carpet type, climate and cleaning conditions. Dry time will vary.

Dry Time Tip: Avoid over-cleaning carpet to ensure faster dry times. See Page 14 for more information on best practice for quicker dry times.

STAIN CLEANING with the hand tool:

1. With the unit in upright position, move the selector lever **DOWN** until it clicks into place.
2. Add the desired tool to the crevice tool.
3. To clean wet messes with the hand tool, first use suction only to remove liquid.
4. Then, spray stained area, scrub using bristles, then use suction until mess is clean and water is extracted.
5. If your model comes with the Shark® Pet stain trapping tool, use it to extract liquid messes until the cup is full, then remove the cup and discard the mess.

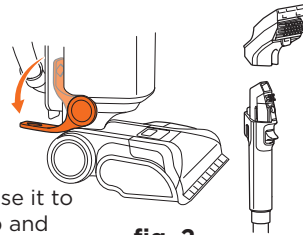
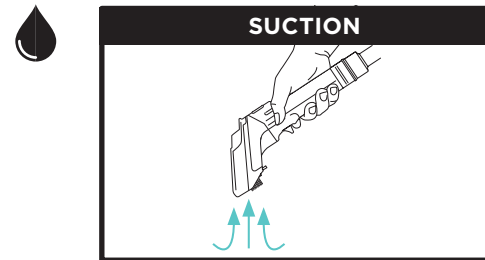

fig. 2

Tip: You may need to repeat cleaning to remove difficult stains.

For best results on wet and dry stains follow the below steps. Before beginning, turn the unit on.



For wet messes, scrub the stain area first and then suction up the excess liquid.

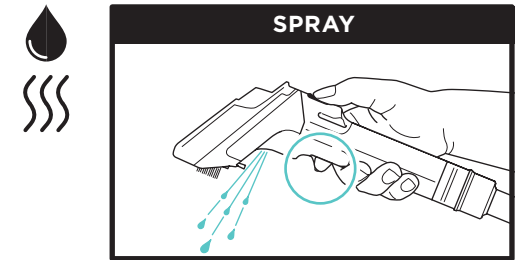

Spray the stained area using the trigger on the underside of the handtool. For older stains, leave to settle.

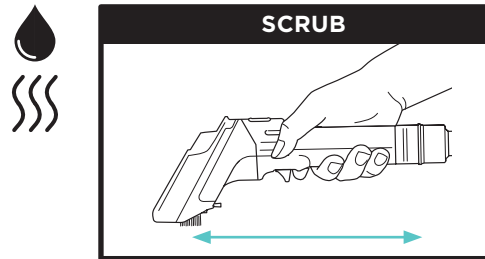

Scrub the stain with the bristles, agitating in multiple directions.

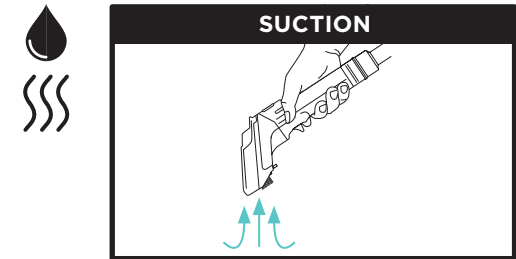

Tilt the handtool forward and drag it across the stain to extract. Repeat steps if needed.

Tip: Avoid over saturating the area, or continual spraying during cleaning.

Tip: Always ensure to use the correct solution dilution measures when setting up the unit for cleaning.

Tip: Choosing the bristles - The rubber bristles are best suited for more delicate surfaces and upholstery. The tough bristles are ideal for stubborn agitation on hard wearing surfaces.

MAINTENANCE

Tip: Clean unit after every use to avoid odours and mould.

Note: When turning off the power, it will take 2 to 3 seconds for the unit to clear the lines and power down completely.

DIRTY WATER TANK

Note: You will hear a change in motor noise/air flow when the dirty water tank is full.

1. Press the release button and remove the tank.
2. Remove the lid - do not try to pour out the contents till this is removed.
3. Discard contents in preferred location e.g. drain and clean the tank with soap (e.g. hand soap, washing up liquid) and water.
4. Remove the filter. Wash the filter by hand with soap and water, rinsing off all suds, then allow it to air-dry completely before reinstalling.

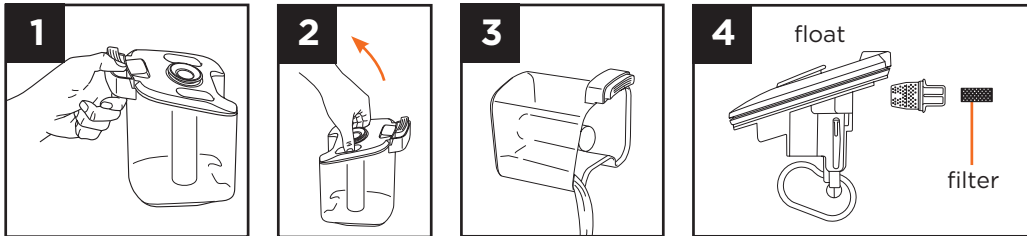

BRUSHROLL

1. Pull the latch to remove outer cover.
2. Lift the inner cover from the top to open, labelled 'LIFT'.
3. Remove the brushroll by pulling up on the side tab. If hair is wrapped, cut it away by running scissors along the groove in the brushroll. Rinse brushroll, cover, and doors and allow them to air-dry before reinstalling.
4. To reinstall the outer cover, connect the 2 hooks at the bottom, then push forward until it clicks into place.

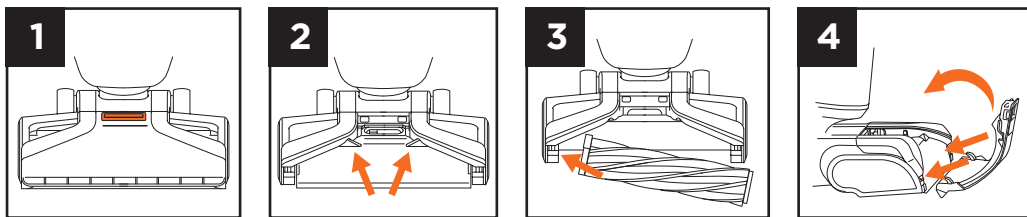

MAINTENANCE

HAND TOOLS

Press the release button to detach tool. Pull tab to remove window and bristle strip. Wash tools with soap and water and allow them to air-dry before reinstalling.

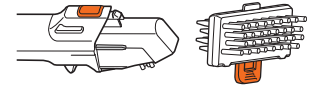

HOSE

Attach the hose-cleaning tool to the end of the crevice tool and turn on power. Pull the trigger and the cleaning solution will be sucked into the hose to clean the interior.

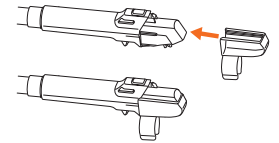

CHECKING FOR DEBRIS

To check airpath for clogs, hair, or debris:

1. Unplug unit.
2. Remove dirty water tank.
3. Remove seal (**fig. 7**).
4. Detach the hose by squeezing the fitment clips on the hose attachment. (**fig. 8**).
5. Remove the selector lever by pushing it all the way forward (**fig. 9**), then pulling it out sideways (**fig. 10**).
6. Remove any debris.
7. Reattach parts.

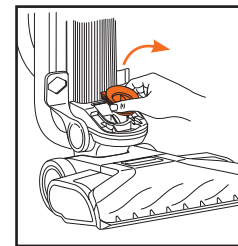

fig. 7

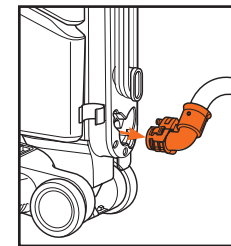

fig. 8

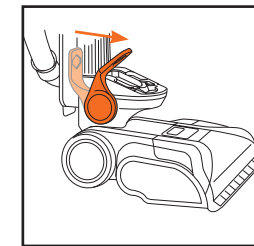

fig. 9

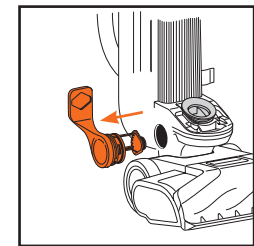

fig. 10

INDICATOR LIGHTS

MODES

- Solid blue on the left
AUTO CLEAN MODE
- Solid blue on the right
DRY ONLY MODE
- Solid green on both sides
HAND TOOL ACTIVATED

NOTIFICATIONS

- Solid red: **BRUSHROLL JAM**
Fix: Remove obstruction, then reinstall brushroll
- Flashing blue: **DIRTY TANK FULL**
Fix: Empty the tank, then reinstall it
- Flashing red: **BRUSHROLL COVER OPEN**
Fix: Close cover
- Flashing green: **SELECTOR LEVER ERROR**
Fix: Move lever to the correct position

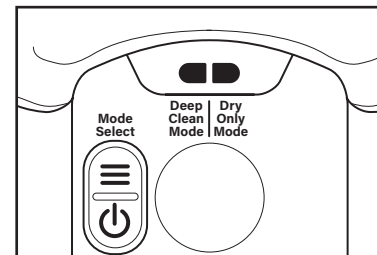

BEST PRACTICE FOR DRYING

To speed up dry time, follow the below best practice steps.

FLOOR NOZZLE

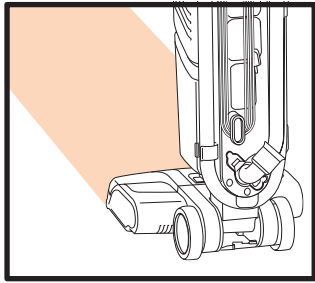

When moving the nozzle follow a uniform pattern, moving back and forth at a slow controlled pace.

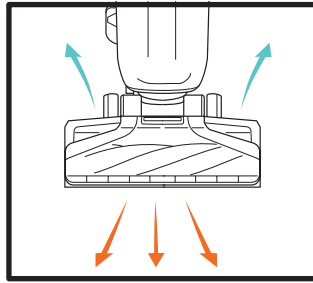

Moving forward dispenses cleaning fluid, moving back extracts the fluid. Try to do a back pass, for each forward one.

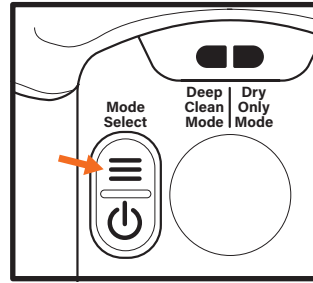

Once satisfied with the clean, press the mode button to enter Dry Only mode – and go back over the entire area. In this mode, no fluid will be dispensed.

Tip: Avoid over-cleaning the same spot in deep clean mode to prevent saturating the carpet leading to longer drying time.

Note: Drying time will take a few hours (cleaning conditions dependent). It's recommended once deep clean is completed, press the mode button to activate 'Dry only' mode and continue to extract excess liquid from carpets. This will help to reduce dry time.

HAND TOOL

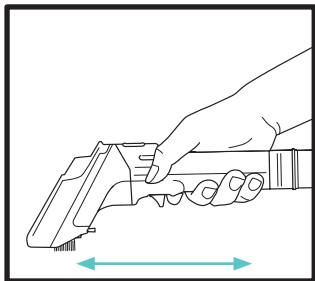

When extracting the liquid, pass over the cleaning area in a uniform pattern, applying downward pressure throughout.

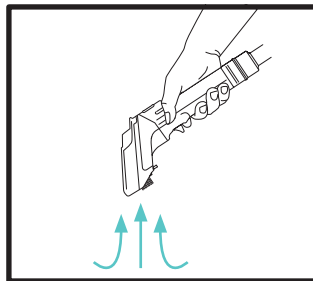

Angle the hand tool to engage the suction vents parallel to the cleaning surface for optimum suction.

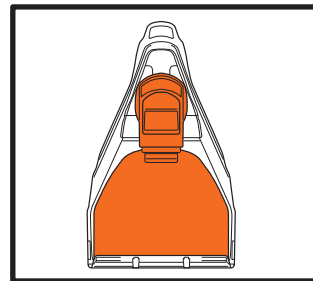

Continue to pass over the cleaning area until liquid is no longer extracting through the hand tool window.

For more information, scan QR code to view HOW TO VIDEOS

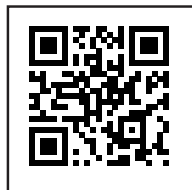

FIVE (5) YEAR LIMITED GUARANTEE

When a consumer buys a product in the UK, they get the benefit of legal rights relating to the quality of the product (your "legal rights"). You can enforce your legal rights against your retailer, including Shark if you bought your Shark appliance from sharkclean.co.uk. However, at Shark we are so confident about the quality of our products that we give the owner an additional, free parts and labour manufacturer's guarantee of up to 5 years. A household appliance like a Shark floorcare appliance constitutes a sizeable investment. Your new machine needs to work properly for as long as possible. The guarantee it comes with is an important consideration - and reflects how much confidence the manufacturer has in its product and manufacturing quality. The manufacturer's guarantee does not affect your legal rights.

How long are new Shark machines guaranteed for?

Our manufacturer's guarantee lasts for one year from the date of purchase as standard, or for five years if you register your purchase with us within 28 days. There is information on how to register below.

How do I register my Shark guarantee?

If you have purchased your Shark appliance directly from sharkclean.co.uk your guarantee is registered automatically. If you bought it from anywhere else, you can register your guarantee online within 28 days of purchase.

- To register online, please visit www.sharkclean.co.uk/register-guarantee or scan the QR code in your instruction manual.
- Keep a note of the date you purchased the machine.

IMPORTANT:

- Keep your receipt if you bought your Shark floorcare appliance from anywhere except sharkclean.co.uk. You will need it to claim under your guarantee.
- The free Shark guarantee only applies to Shark owners living permanently in the UK.

What are the benefits of registering my free Shark guarantee?

When you register your guarantee, you will get an extra four years of cover. We'll also have your details to hand if we ever need to get in touch. If you further agree to receive communications from us, you can also receive tips and advice on how to get the best out of your Shark floorcare appliance and hear the latest news about new Shark technology and launches.

What is covered by the free Shark guarantee?

Repair or replacement (at Shark's option) of your Shark machine, including all parts and labour.

What is not covered by the free Shark guarantee?

- Normal wear and tear.
- Accidental damage or faults caused by negligent use or care, misuse, neglect, careless operation, or handling of the Shark appliance which is not in accordance with the Shark Operating Manual supplied with your machine.
- Damage caused by use of the Shark appliance for anything other than normal domestic household purposes.
- Damage caused by use of parts not assembled or installed in accordance with the operating instructions.
- Damage caused by use of parts and accessories which are not Shark Genuine Components
- Faulty installation (except where installed by Shark).
- Repairs or alterations carried out by parties other than Shark or its agents.

How can I claim under the free Shark guarantee?

Contact our customer service helpline on **0800 862 0453**. For service hours please visit our website under 'Contact Us'. It's free to call, and you'll be put straight through to a Shark representative. You'll also find online support at <https://support.sharkclean.co.uk>. The Shark representative will go through some troubleshooting with you, and if we conclude that the item has failed, we will send you a replacement part or a returns label to send the defective item back to us free of charge. When you have delivered the defective product to us, we will send you a replacement.

Please remember that the item will need to be boxed when you return it to us, which can be any suitable box; it does not have to be the original packaging.

Where can I buy genuine Shark spares and accessories?

Shark spares and accessories are developed by the same engineers who developed your Shark floorcare appliance. You'll find a full range of Shark spares, replacement parts and accessories for all Shark machines at www.sharkclean.co.uk. Please remember that damage caused by the use of non-Shark spares may not be covered under your guarantee.





PLEASE READ CAREFULLY AND KEEP FOR FUTURE REFERENCE.

This Instruction Booklet is designed to help you get a complete understanding of your new Shark® carpet cleaner.

**SharkNinja Europe Limited,
3150 Century Way, Thorpe Park,
Leeds, LS15 8ZB, UK
+44 (0)800 862 0453
www.sharkclean.co.uk**

**SharkNinja Germany GmbH,
Rotfeder-Ring 9,
60327 Frankfurt am Main, Germany
www.sharkclean.eu**

Illustrations may differ from actual product. We are constantly striving to improve our products; therefore the specifications contained herein are subject to change without notice.

© 2023 SharkNinja Operating LLC. SHARK is a registered trademark in the United Kingdom of SharkNinja Operating LLC.

CARPETXPERT is an unregistered trademark in the United Kingdom of SharkNinja Ltd Operating LLC.
