

# ***Shark*** **CarpetXpert**

## **HairPro Pet**

---

**EX300  
SERIES**

---

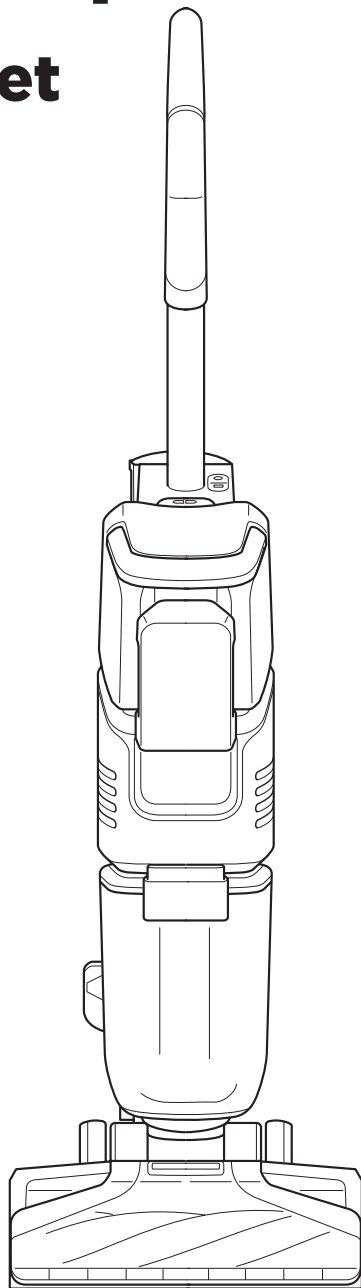

To view **HOW-TO VIDEOS**  
scan QR Code located on  
top of CarpetXpert Tank.

# THANK YOU



for purchasing the Shark CarpetXpert HairPro Pet



 **TIP:** You can find the model and serial numbers on the QR code label located on the back of your unit.

## REGISTER YOUR PURCHASE

### TO BENEFIT FROM YOUR PRODUCT'S EXTENDED GUARANTEE, SIMPLY REGISTER YOUR PURCHASE AT:

-  [sharkclean.co.uk/register-guarantee](http://sharkclean.co.uk/register-guarantee)
-  +44 (0)800 862 0453
-  Scan QR code using mobile device

Please note, products purchased directly from Shark are automatically registered.

Benefits of registering your product and creating an account:

- Get easier, faster product support and access to guarantee information
- Access troubleshooting and product care instructions
- Be among the first to know about exclusive product promotions

### RECORD THIS INFORMATION

Model Number: \_\_\_\_\_

Serial Number: \_\_\_\_\_

Date Code: \_\_\_\_\_

Date of Purchase (Keep Receipt): \_\_\_\_\_

Store of Purchase: \_\_\_\_\_

### TECHNICAL SPECIFICATIONS

Voltage: 220 - 240V

Watts: 1000W

### PLEASE READ CAREFULLY AND KEEP FOR FUTURE REFERENCE.

This instruction manual is designed to help you get a complete understanding of your new Shark CarpetXpert Hair Pro Pet.

If you have any questions, please call the customer service line on +44 (0)800 862 0453.



# CONTENTS

<b>Important Safety Instructions</b> .....	<b>4</b>
<b>What's Included</b> .....	<b>6</b>
<b>Assembly</b> .....	<b>7</b>
<b>Hose Assembly</b> .....	<b>8</b>
<b>Cleaning Solution and Tanks</b>	
Shark Cleaning Solutions.....	9
Filling the Tanks.....	9
<b>Accessories</b>	
Selecting the correct tool.....	10
Tool guide.....	11
Cleaning and Drying tips.....	11
<b>How to use CarpetXpert HairPro Pet</b>	
Cleaning with CarpetXpert.....	12
Cleaning with StainStriker.....	12
Hand Tool Cleaning Guide.....	13
<b>Maintenance</b>	
Cleaning the Dirty Water Tank.....	14
Cleaning the Brush-Roll.....	14
Cleaning the Hand Tools & Hose (Rinse & Go).....	15
Checking for Debris.....	15
Cleaning the Diverter Valve.....	15
<b>Best Practices</b>	
Best Practice Floor Nozzle Use.....	16
Best Practice Stain Cleaning.....	16
Best Practice for Faster Dry Time.....	16
<b>Indicator Lights</b> .....	<b>17</b>
<b>Troubleshooting</b> .....	<b>17</b>
<b>Guarantee</b> .....	<b>18</b>



This marking indicates that this product should not be disposed with other household wastes. To prevent possible harm to the environment or human health from uncontrolled waste disposal, recycle it responsibly to promote the sustainable reuse of material sources. To return your used device, please use the return and collection systems or contact the retailer where this product was purchased. They can take this product for environmentally safe recycling.

# IMPORTANT SAFETY INSTRUCTIONS

FOR HOUSEHOLD USE ONLY • PLEASE READ ALL INSTRUCTIONS BEFORE USING THIS CARPET EXTRACTOR.

To reduce the risk of shock and unintended operation, turn off power before servicing. If the supply cord is damaged, it must be replaced by the manufacturer, its service agent, or similarly qualified persons in order to avoid a hazard.

## ⚠ WARNING

REDUCE THE RISK OF FIRE, ELECTRIC SHOCK, INJURY, OR PROPERTY DAMAGE:

1. If the power cord plug does not fit fully into the socket, contact a qualified electrician. **DO NOT** force into socket or try to modify to fit.
2. To reduce the risk of shock and unintended operation, unplug before servicing.
3. This carpet cleaner consists of a motorised nozzle, main body, pole, handle, hose, and hand tools. Some of these components contain electrical connections, electrical wiring, and moving parts that potentially present risk to the user.
4. Before each use, carefully inspect all parts for any damage. If a part is damaged, discontinue use.
5. Use only identical Shark® replacement parts.
6. **DO NOT** use the carpet cleaner for any purpose other than those described in this booklet.
7. **DO NOT** immerse or spray water on the body of the carpet cleaner. To clean the surface, wipe with a dry cloth.
8. Keep the carpet cleaner's cord out of reach of children.
9. **DO NOT** allow the appliance to be used by children. **DO NOT** allow to be used as a toy. Close supervision is necessary when used near children. Cleaning and user maintenance must not be done by children.
10. This appliance can be used by persons with reduced physical, sensory or mental capabilities or lack of experience or knowledge if they have been given supervision or instruction concerning use of the appliance in a safe way and understand the hazards involved.
11. **DO NOT** handle plug or carpet cleaner with wet hands.
12. **DO NOT** use without the dirty water tank, clean solution tank, filter, brushroll, and brushroll cover in place.
13. Only use Shark® branded filters and accessories.
14. **DO NOT** put any objects into nozzle opening. **DO NOT** use with any opening blocked; keep free of dust, lint, hair, and anything that may reduce airflow.
15. **DO NOT** use if nozzle airflow is restricted. If the air paths or the motorised floor nozzle become blocked, turn the carpet cleaner off. Remove all obstructions before you turn on the unit again. Keep nozzle and all carpet cleaner openings away from hair, face, fingers, uncovered feet, or loose clothing.
16. **DO NOT** use if carpet cleaner is not working as it should, or has been dropped, damaged, left outdoors, or dropped into water.
17. Use extra care when cleaning on stairs.
18. **DO NOT** leave the carpet cleaner unattended while plugged in.
19. When using on any surface, always keep the carpet cleaner moving to avoid damaging the surface (e.g., carpet fibres).
20. **DO NOT** place carpet cleaner on unstable surfaces such as chairs or tables. The surrounding area may be slippery and present a risk of injury.
21. **DO NOT** use to pick up:
  - a) Large objects.
  - b) Hard or sharp objects (glass, nails, screws, or coins).
  - c) Large quantities of dust (e.g., drywall dust).
  - d) Smoking or burning objects (hot coals, cigarette butts, or matches).
  - e) Flammable or combustible materials (lighter fluid, petrol, or kerosene).
  - f) Toxic materials (chlorine bleach, ammonia, or drain cleaner).
22. **DO NOT** use in the following areas:
  - a) Poorly lit areas.
  - b) Outdoor areas.
  - c) Spaces that are enclosed and may contain explosive or toxic fumes or vapours (lighter fluid, petrol, kerosene, paint, paint thinners, mothproofing substances, or flammable dust).
23. The plug must be removed from the socket-outlet before any adjustment, cleaning or maintenance of the appliance.
24. During cleaning or routine maintenance, **DO NOT** cut anything other than hair, fibres, or string wrapped around the brushroll.
25. **DO NOT** modify or attempt to repair the carpet cleaner yourself. **DO NOT** use the carpet cleaner if it has been modified or damaged.
26. Turn off all controls before unplugging.
27. To reduce the risk of fire or electric shock due to internal component damage, use only Shark® cleaning solution. See the Cleaning Fluid section of this Instruction Booklet.
28. **DO NOT** pull or carry by cord, use cord as a handle, close a door on cord, or pull cord around sharp edges or corners. **DO NOT** run appliance over cord. Keep cord away from heated surfaces.
29. **DO NOT** unplug by pulling on cord. To unplug, grasp the plug, not the cord.
30. Use indoors only.
31. **DO NOT** use carpet cleaner on hard floors or wool as it may damage your floor. To avoid damage to flooring and to avoid potential slip hazard, after use: (a) move to a hard sealed surface (avoid unsealed, wood and laminate) and (b) place unit on absorbent material like a towel to soak up any liquid.
32. **DO NOT** fill solution tanks while installed on the appliance. Remove before filling.
33. **DO NOT** use vinegar in any tanks.
34. The areas around where you are cleaning may become wet, use care to avoid slipping and falling.
35. Use care when removing and reattaching the hand tool to the crevice tool to avoid accidental activation of the cleaning solution. **DO NOT** spray solution on your skin or in your eyes.
36. Improper connection of the equipment grounding conductor can result in a risk of electric shock. Check with a qualified electrician or service person if you are in doubt as to whether the socket is properly grounded. **DO NOT** modify the plug provided with the appliance. If the plug will not fit the socket, have a proper socket installed by a qualified electrician.
37. This appliance is for use on a nominal V circuit and has a grounding attachment plug that looks like the plug illustrated below. Make sure that the appliance is connected to a socket having the same configuration as the plug. No adaptor should be used with this appliance.
38. **DO NOT** immerse. To reduce risk of electric shock, use only on carpet moistened by cleaning.

39. **DO NOT** run over edges of area rugs.
40. Stalling the brush roll may result in premature belt failure.
41. Avoid repeated strokes over the same area, to help prevent damage to Berber/ Loop Pile carpets.
42. Check manufacturer's tag prior to cleaning area rugs for any specific cleaning guidelines. We **DO NOT** recommend deep cleaning delicate rugs (including silk, antique, or area rugs that **DO NOT** have a manufacturer's tag).
43. **DO NOT** store unit where temperatures reach freezing levels to avoid damaging internal parts.
44. **FIRST AID** Keep out of reach of children. Causes skin and serious eye irritation. **IF IN EYES**, rinse continuously with water for minutes. Remove contact lenses if present and easy to do so. Continue rinsing. **IF ON SKIN**, wash with soap and water. If skin and eye irritation persists, seek medical attention. Please recycle container. Dispose of contents/container with a licensed waste disposal site in accordance with the requirements of the local waste disposal authority. **DO NOT** dispose in drains or watercourses in concentrate form.

## SAVE THESE INSTRUCTIONS

## WHAT'S INCLUDED

**What's Included:** Shark® CarpetXpert, 355ml. Shark Deep Clean Pet, 473ml. Shark OXY Multiplier, Hand Tool(s).

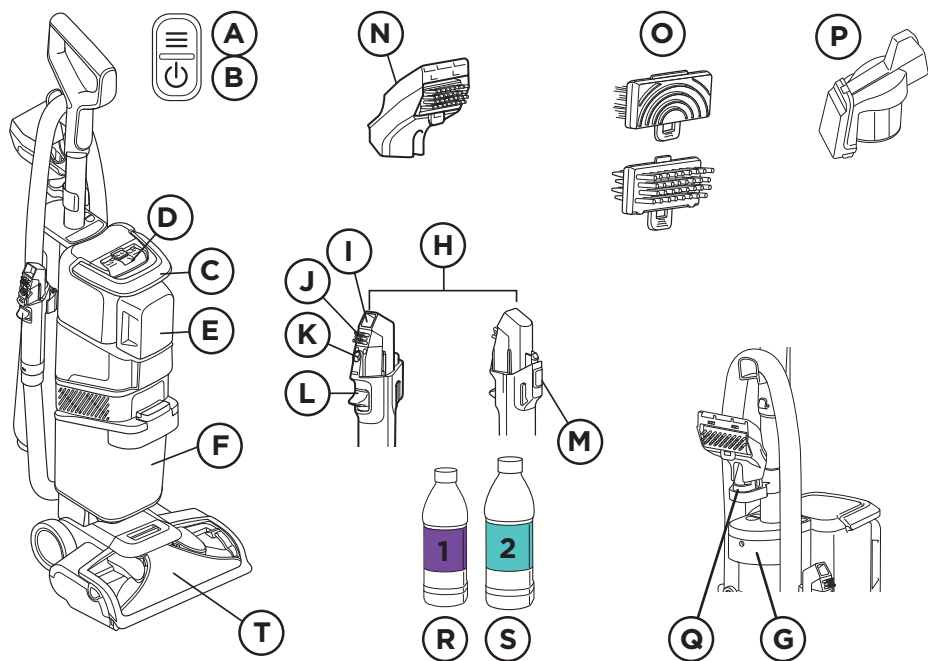

The HairPro Wide Tough Stain Tool and HairPro Pet Stain Trapping Tool are included with selected models, and are available for purchase at [sharkclean.co.uk](http://sharkclean.co.uk)



- |                                 |                                       |
|---------------------------------|---------------------------------------|
| <b>A</b> Mode Button            | <b>K</b> Spray Outlet                 |
| <b>B</b> Power Button           | <b>L</b> Hand Tool Trigger            |
| <b>C</b> CarpetXpert™ Tank      | <b>M</b> Hand Tool Release Button     |
| <b>D</b> Rinse & Go             | <b>N</b> HairPro Tough Stain Tool     |
| <b>E</b> StainStriker™ Tank     | <b>O</b> Reversible Bristles          |
| <b>F</b> Dirty Water Tank (DWT) | <b>P</b> HairPro Pet Hair Extractor   |
| <b>G</b> Carry Handle           | <b>Q</b> Tool Mount                   |
| <b>H</b> HairPro Creative Tool  | <b>R</b> 355ml Deep Clean PEt Formula |
| <b>I</b> Suction Inlet          | <b>S</b> 473ml Oxy Multiplier Formula |
| <b>J</b> Removable Bristles     | <b>T</b> Floor Nozzle                 |

## ASSEMBLY

1. Insert handle into the top of unit until it clicks into place (**fig. 1**).
2. Clip the tool holder onto the handle (**fig. 2**).
3. Attach chosen hand tool to HairPro Crevice Tool, or place on the Tool holder (**fig. 3**).
4. Be sure the rubber seal is seated in place under the dirty water tank (**fig. 4**).
5. Install the dirty water tank by placing the bottom on the nozzle lip then tilting it forward until it clicks into place (**fig. 5**).

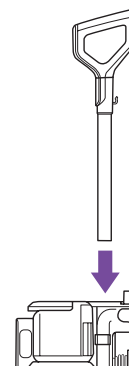

fig. 1

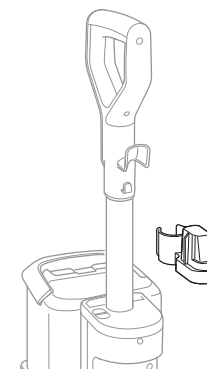

fig. 2



fig. 3

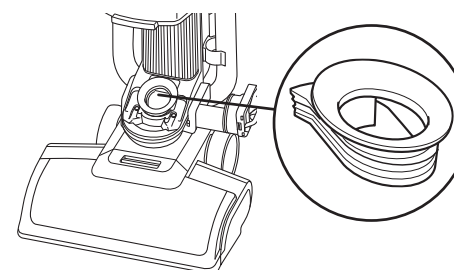

fig. 4

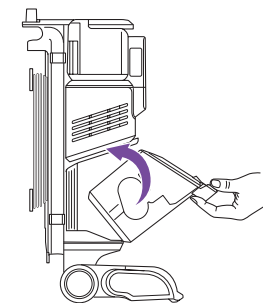
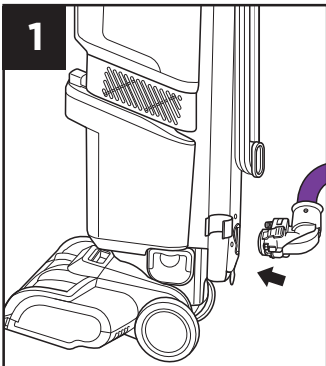

fig. 5

**Tip:** Store your tool on the Tool Holder when not in use.

## HOSE ASSEMBLY



Insert hose **tightly** into back of unit until it **clicks twice** to avoid leaks.

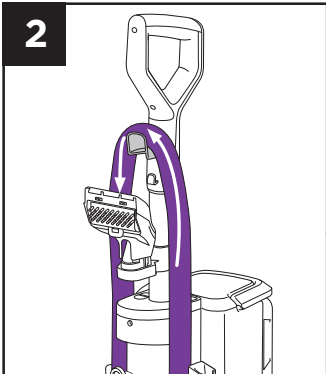

Run hose through first clip, then loop it **tightly** over the top tab.

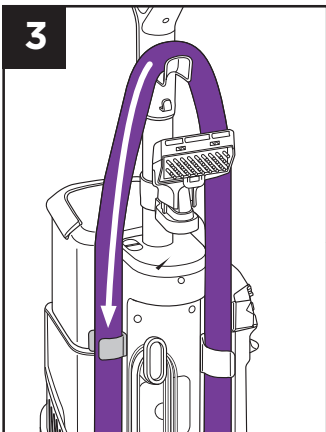

Press hose into second clip.

**TIP:** Wrap hose tightly, leaving no slack

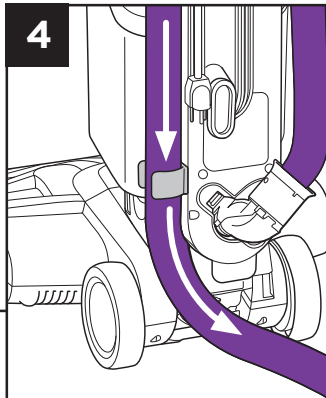
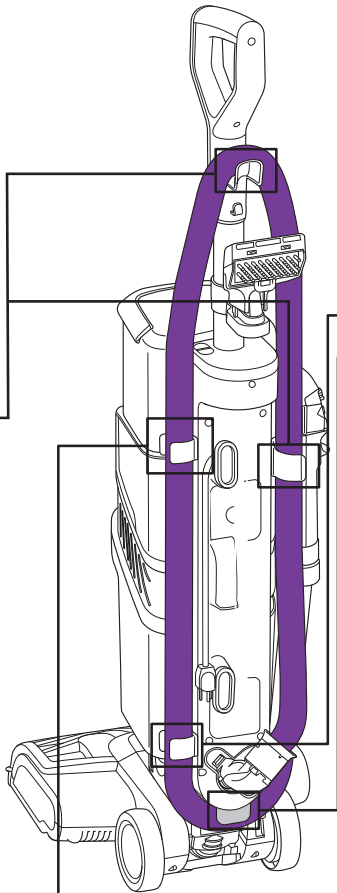

Press hose into third clip.

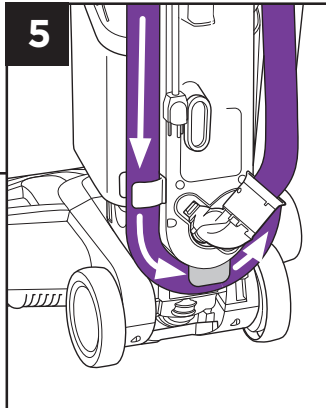

Loop hose **tightly** under the bottom tab.

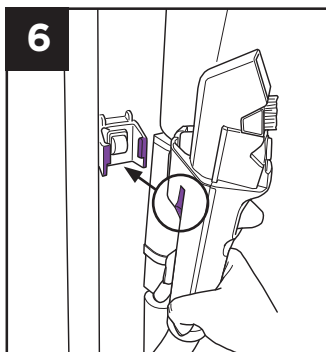

Align the grooves in the hand tool with the grooves in the holder, then slide the tool down to attach.

## SHARK® CLEANING SOLUTIONS AND TANKS

### SHARK CLEANING SOLUTIONS

Use **ONLY** Shark branded cleaning solutions. Taking care to use the CarpetXpert/StainStriker formulas in the correct tanks. Unit is not compatible with other solutions or cleaners.



**Shark Deep Clean Pet**  
For deep-cleaning carpets with the brushroll



**Shark OXY Multiplier**  
For stain cleaning with the hand tool, combines with Shark Deep Clean Pet to help eliminate tough stains.

### FILLING THE TANKS

#### Filling the CarpetXpert Tank (top clear tank)

1. Lift the CarpetXpert Tank by the handle to detach it, then remove the cap.
2. Add warm water to the tank up to the WATER fill line. Do not use water hotter than 60°C (140°F).
3. Add Shark Shark Deep Clean Pet up to the CONCENTRATE fill line.
4. Reattach cap, then reinstall the CarpetXpert Tank, hearing a 'click' once installed properly.

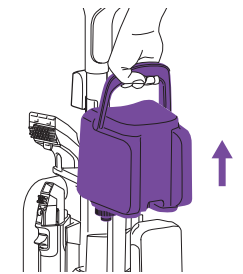

#### Filling the StainStriker Tank (smaller, blue tank)

1. Lift the StainStriker Tank by its sides to detach it, then remove the cap.
2. Add Shark OXY Multiplier up to the MAX FILL line.
3. Reattach cap, then reinstall the StainStriker tank, hearing a 'click' once installed properly.

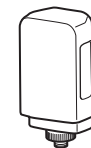



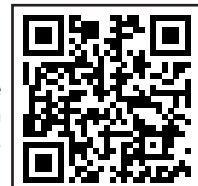

**Tip:** Use the carry handle located on back of unit (G) when moving up and down stairs. To reduce weight when carrying, fill tanks once you are at cleaning area and ready to clean.

To order refills and explore our complete solution range, scan the QR code.

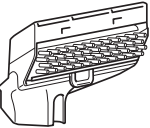

## ACCESSORIES

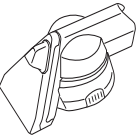
	HairPro Integrated Crevice Tool	HairPro Tough Stain Tool	HairPro Wide Tough Stain Tool	HairPro Pet Hair Extractor	HairPro Pet Mess Tool
					
<b>Tough Stains</b>	✓	✓	✓		
<b>Light Stains</b>	✓*	✓*	✓*	✓	✓
<b>Large Stains</b>			✓		
<b>Light Hair Pick Up</b>	✓	✓	✓	✓	
<b>Heavy Hair Pick Up</b>				✓	
<b>Pet Mess Pick Up</b>					✓
<b>For WET Use (With Solution)</b>	✓	✓	✓	✓	✓
<b>For DRY Use (Without Solution)</b>	✓	✓	✓	✓	✓
<b>Rinse &amp; Go Self Wash</b>	✓	✓			

\*Use Hair Gripping Fins/Rubber Agitators.

**NOTE:** Clean each tool after use and allow to dry fully before storing.

## ACCESSORIES

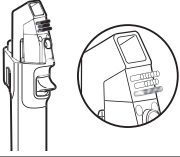
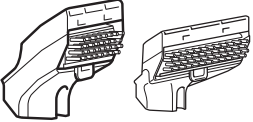
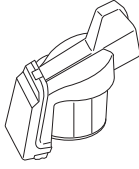
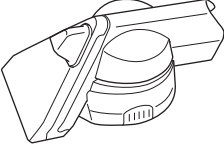
<b>HairPro Integrated Crevice Tool</b>		<b>For hard-to reach areas and small stains.</b> <b>Tips:</b> <ul style="list-style-type: none"> <li>• Swap between Bristles for tough stains, and Rubber Agitators for light stains or cleaning delicate surfaces.</li> <li>• To remove the bristles, squeeze the indents and pull outwards.</li> <li>• Clean with Rinse &amp; Go Self Wash.</li> </ul>
<b>Hairpro Tough Stain Tools</b>		<b>For larger stains and deeper cleans.</b> <b>Tips:</b> <ul style="list-style-type: none"> <li>• Swap between Bristles for tough stains, and Hair Gripping Fins for light hair pick up &amp; stains or cleaning delicate surfaces.</li> <li>• Clean the HairPro Tough Stain Tool with Rinse &amp; Go Self Wash.</li> <li>• Clean the HairPro Wide Tough Stain Tool by removing the window and rinsing in water.</li> </ul>
<b>HairPro Pet Hair Extractor</b>		<b>For heavy hair pickup &amp; light stains.</b> <b>Tips:</b> <ul style="list-style-type: none"> <li>• Use short backwards strokes to collect the surface hair.</li> <li>• Twist the cup to remove, empty and clean.</li> <li>• Empty the cup frequently to maintain performance.</li> <li>• The mesh filter can be twisted and removed for separate cleaning.</li> <li>• The front window can be removed for cleaning. To replace, align the lower part first before clipping into place.</li> </ul>
<b>Hairpro Pet Mess Tool</b>		<b>Captures unhygienic pet messes - and prevents them from contaminating your unit.</b> <b>Tips:</b> <ul style="list-style-type: none"> <li>• Spray, Scrub and extract the stain.</li> <li>• Twist the cup to remove, empty and clean.</li> <li>• Empty the cup regularly.</li> <li>• Keep tool level to reduce spillage.</li> <li>• The mesh filter can be flipped down and removed for cleaning.</li> <li>• The front window can be removed for cleaning. To replace, align the lower part first before clipping into place.</li> </ul>

## CLEANING AND DRYING TIPS

### CLEANING:

- Avoid oversaturating the stain by continually spraying.
- Allow the solution to sit for 5-20mins on older stains.
- Clean fresh stains immediately.
- Scrub in multiple directions for enhanced stain removal.
- Ensure solution is correctly diluted.

### DRYING:

- Apply even and constant pressure when extracting excess liquid.
- Angle the tool forward slightly to engage the vents fully to the surface, for optimum suction.
- Continue passing over the surface until no more liquid is removed.



For information, scan QR to view **HOW-TO VIDEOS**

**DEEP CLEANING** with the brushroll:  
*Uses Deep Clean Pet cleaning solution and water*

**Important:** Vacuum with traditional vacuum cleaner first

1. Gently step on the base and tilt the handle back (fig. 1).
2. Press power button; unit will enter 'Deep Clean' Mode.
3. Move unit forward slowly; it will automatically dispense water and Deep Clean Pet cleaning solution.
4. On the backpass, the unit will use suction to extract liquid and aid the drying process.
5. Repeat steps 3 and 4.
6. Once deep clean is complete, press the Mode button, to activate Dry Only mode. Repeat passes over the entire cleaning area multiple times to help to reduce dry time.

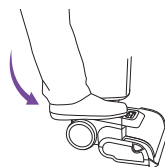

fig. 1

**Note:** Dry time can be impacted by carpet type, climate and cleaning conditions. Dry time will vary.

**Dry Time Tip:** Avoid over-cleaning carpet to ensure faster dry times. See Page 16 for more information on best practice for quicker dry times.

**STAIN CLEANING** with the hand tool:  
*Uses Deep Clean Pet + OXY Multiplier*

1. Lift the HairPro Crevice Tool to automatically switch to Hand Tool Mode.
2. Add the desired tool to the HairPro Crevice Tool (fig.2).
3. To clean wet messes with the hand tool, first use suction only to remove liquid.
4. Then, spray stained area, scrub using bristles, then use suction until mess is clean and water is extracted.
5. If your model comes with the HairPro Pet Stain Trapping Tool, use it to extract liquid messes until the cup is full, then remove the cup and discard the mess.



fig. 2

**AREA RUGS**

- Check manufacturer's label prior to cleaning and follow all guidelines. We DO NOT recommend cleaning delicate rugs (including wool, cotton, silk, antique, or rugs that DO NOT have a manufacturer's tag).
- We recommend first testing a small discrete spot as a test before beginning a full deep clean.

**Tip:** Be mindful of edges when cleaning area rugs. If your area rug has decorative or loose fibers, do not run CarpetXpert near edges.

**Tip:** You may need to repeat cleaning to remove difficult stains.

**WET STAIN CLEANING**

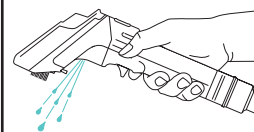

1. Follow the stain guide located on the HairPro Crevice Tool.
2. Turn on the unit and vacuum up the liquid mess.
3. Spray and scrub the stain.
4. Tilt the tool forward to extract the stain and any excess liquid.
5. Repeat if necessary.

**DRY STAIN CLEANING**

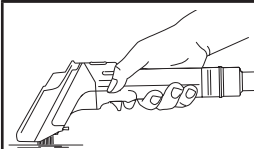

1. Follow the stain guide located on the HairPro Crevice Tool.
2. Scrub the stain.
3. Turn on the unit.
4. Spray and scrub the stain.
5. Tilt the tool forward to extract the stain and any excess liquid.
6. Repeat if necessary.

**HAIR PICKUP**

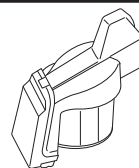

1. Use the Gripping Fins/Rubber Agitators.
2. Before cleaning the stain, use short backwards strokes to collect surface hair.
3. Frequently tilt the tool forward to vacuum up the hair.
4. Refer to the cleaning guide above & Accessories section for tips on hair pickup.

**Note:** For surfaces with heavy hair, use the HairPro Pet Hair Extractor.

**Pet Mess Cleaning**



- Use the HairPro Pet Mess Trapping Tool to prevent unhygienic messes entering your unit.
- Spray, scrub and extract the stain, keeping the tool level.
- DO NOT exceed the MAX FILL line of the cup. After use, turn off the power to the unit and empty the tool cup where appropriate.
- Wash the window, cup, filter and rest of the body thoroughly with soapy water.
- See the Accessory guide for tool tips.

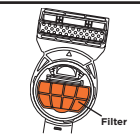
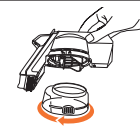

**CREVICE CLEANING**

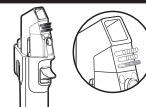

- For hard-to-reach areas, use the integrated HairPro Crevice Tool.
- Swap the bristles from tough stain to rubber agitators depending on stain or hair cleaning.
- Follow the cleaning guides above.

**REVERSIBLE BRISTLES**



- The HairPro Tough Stain Tool, HairPro Wide Tough Stain Tool and Integrated HairPro Crevice Tool all feature swappable bristles.
- The tough stain bristles are best suited for tough stain cleaning whereas Hair Gripping Fins are designed for hair collection and stain cleaning on delicate surfaces.

## MAINTENANCE

**Tip:** Clean unit after every use to avoid odours and mould.

**Note:** When turning off the power, it will take 2 to 3 seconds for the unit to clear the lines and power down completely.

### DIRTY WATER TANK

**Note:** When the dirty water tank is full, there will be a change in motor noise, two indicator lights will flash blue and the unit will switch off.

1. Press the release button and remove the tank.
2. Lift off the lid and inner float mechanism. DO NOT pour out dirty water until float is removed.
3. Pour dirty water from the tank away where suitable.
4. Tap out the captured hair and debris from the basket over a bin. Rinse the tank and basket and allow to air-dry completely before reinstalling.
5. Remove the filter cover, then lift out the filter. Wash the filter with soap and water, then allow it to air-dry completely before reinstalling.
6. Be sure to return the filter to the dirty water tank before reinstalling it. For long-term storage, allow tank to air-dry completely before reinstalling it.

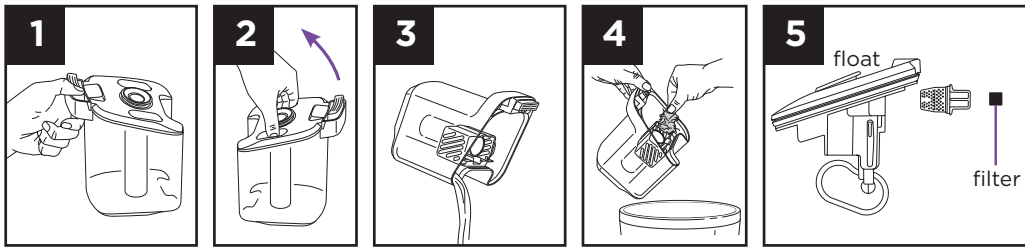

### BRUSHROLL

1. Pull the latch to remove outer cover.
2. Lift the inner cover by pulling from the opening indicated by the arrows.
3. Remove the brushroll by pulling up on the side tab. If hair is wrapped, cut it away by running scissors along the groove in the brushroll. Rinse brushroll, cover, and doors and allow them to air-dry before reinstalling.
4. To reinstall the outer cover, connect the 2 hooks at the bottom, then rotate forward until it clicks into place.

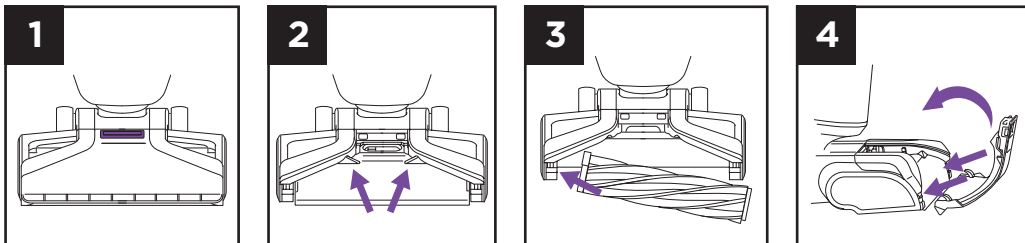

## MAINTENANCE

### HAND TOOLS/HOSE

To use the Rinse & Go feature to clean your hand tools and hose:

1. Turn on power.
2. Align the hand tool and press down to engage the self-cleaning button to flush the hand tool with cleaning solution.
3. Tilt the tool up and down while shaking the hose for optimal, even cleaning.
4. After cleaning is complete, hold the tool up high and let unit run for 3 seconds.
5. Turn Off power

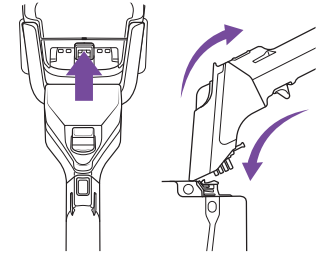

**Note:** The Rinse & Go feature is only compatible with the HairPro Crevice Tool and HairPro Tough Stain Tool.

For the other tools, remove the window, cups, filters and bristles (if applicable) and clean with soapy water. Allow all tools to dry before storing.

### CHECKING FOR DEBRIS

To check airpath for clogs, hair, or debris:

1. Unplug unit.
2. Remove dirty water tank.
3. Remove seal (**fig. 7**).
4. Detach the hose by squeezing the fitment clips on the hose attachment. (**fig. 8**).
5. With the unit stood upright, remove the cartridge by flipping the handle down (**fig 9.**), then pulling it out sideways.
6. Remove any debris.
7. Reattach parts, ensuring the cartridge clicks into place.
8. Check the connection where the hose attaches to the bottom of the unit and clean out any debris there (fig. 11).

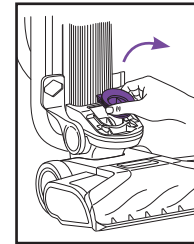

fig. 7

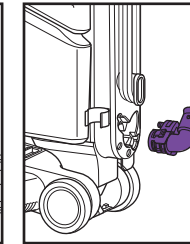

fig. 8

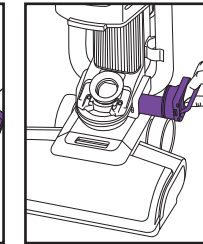

fig. 9

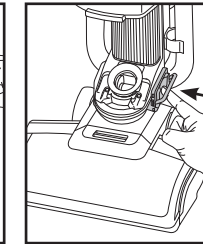

fig. 10

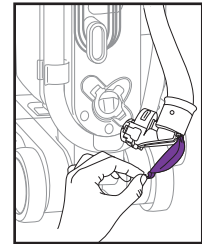
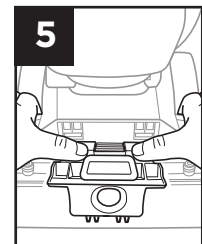
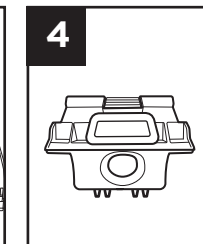
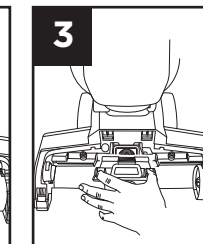
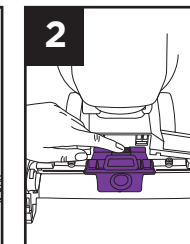
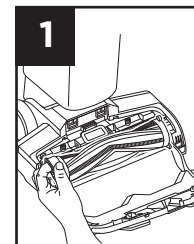

fig. 11

### CLEANING THE DIVERTER VALVE

1. Clean the diverter valve behind the brushroll after every use.
2. Remove the brushroll.
3. Press the release button at the top of the diverter valve, then pull out the diverter valve.
4. Rinse or wipe away any stuck debris or hair from the diver valve and bristle foot, ensuring everything moves freely.
5. Rinse the diverter valve and allow it to air-dry completely before storing the CarpetXpert.
6. Reinsert the valve by inserting bottom first and rotating upwards and secure it by pushing firmly until it clicks into place.





## BEST PRACTICE FOR DRYING

To speed up dry time, follow the below best practice steps.

### FLOOR NOZZLE

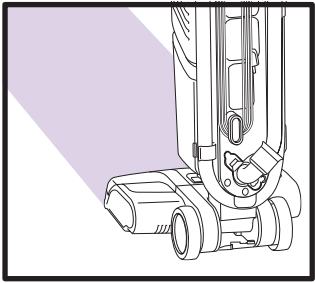

When moving the nozzle follow a uniform pattern, moving back and forth at a slow controlled pace.

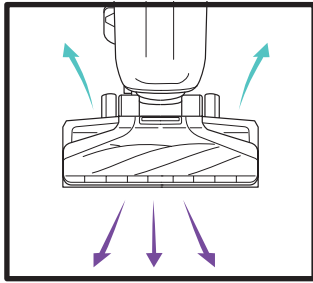

Moving forward dispenses cleaning fluid, moving back extracts the fluid. Try to do a back pass, for each forward one.

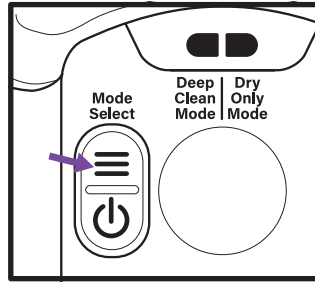

Once satisfied with the clean, press the mode button to enter Dry Only mode - and go back over the entire area. In this mode no fluid will be dispensed.

**Tip:** Avoid over-cleaning the same spot in deep clean mode to prevent oversaturating the carpet leading to longer drying time.

**Note:** Drying time will take a few hours (cleaning conditions dependent). It's recommended once deep clean is completed, press the mode button to activate 'Dry only' mode and continue to extract excess liquid from carpets. This will help to reduce dry time.

### HAND TOOL

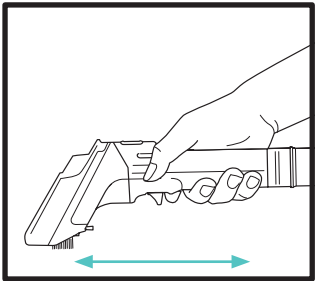

When extracting the liquid, pass over the cleaning area in a uniform pattern, applying downward pressure throughout.

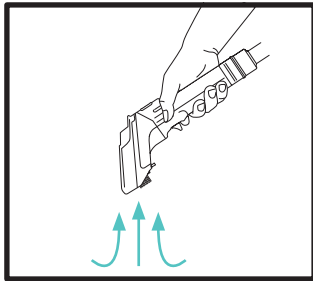

Angle the hand tool to engage the suction vents parallel to the cleaning surface for optimum suction.

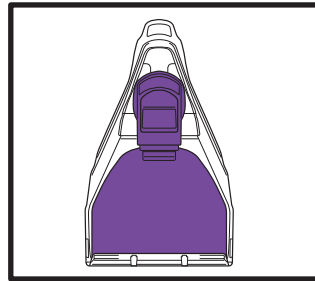

Continue to pass over the cleaning area until liquid is no longer extracting through the hand tool window.

For more information, scan QR code to view **HOW TO VIDEOS**



## INDICATOR LIGHTS

### LED Warnings

Door Open	Dirty Water Tank Full	Hair Clog	Brushroll Jam
Both blinking red	Both blinking blue	Top blinking red, bottom blinking blue	Steady red

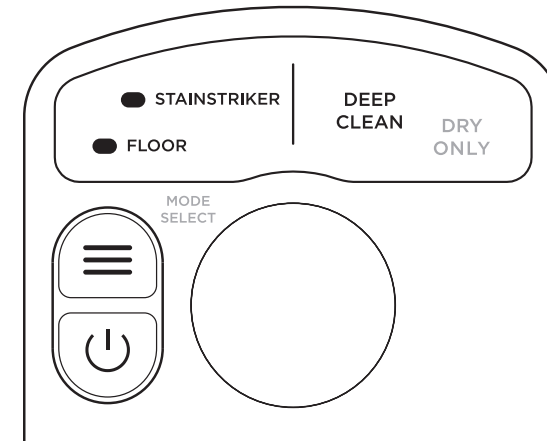

Problem	Solution
<b>Leaking</b>	Check the hose is assembled and connected as per the instructions in this booklet. Ensure the hose elbow access hatch is firmly closed. Ensure the caps on the tanks are tightened securely.
<b>Poor suction</b>	Make sure all parts are connected securely and the hose clicks twice when attaching it to the back of the unit. See Checking for Debris section above for more information.
<b>Hand tool not spraying</b>	Be sure cartridge and hose are properly inserted. Both solution tanks should be full and fully inserted. Unit needs to be in upright position to use hand tool.
<b>Floor nozzle not dispensing solution</b>	Ensure the unit is reclined and the solution tanks are full. Make sure the cartridge is properly installed and clicks securely into place.
<b>Oxy Multiplier is not being dispensed</b>	Be sure tanks are attached securely and they contain solution.
<b>The Dirty Water Tank Full indicator lights are on, but the tank is not full</b>	Make sure the cartridge is installed properly. (See Checking For Debris section for more information). Remove the dirty water tank, clean it, reinstall it, then restart the unit.
<b>Rinse &amp; Go/Self-Wash is not working with a hand tool</b>	Be sure that the tip of the clear window is fully inserted into the Self-Wash groove. If Self-Wash is still not working, rock the hand tool back and forth to improve liquid flow. Ensure there is enough liquid in the clean water tank.
<b>Seeing clumps on the floor while cleaning</b>	Pass over the hair a second time at a slower pace. (Slower than you would use with a vacuum cleaner)
<b>Debris is stuck in the hose</b>	While using Self-Wash, tap or shake the hose to help clear debris.
<b>Hair Clog Indicator lights are flashing</b>	Remove the Diverter valve (see maintenance section). Thoroughly clean the diverter valve, being careful to remove any stuck debris, hair or dirt. Dry and re-insert into the unit.
<b>Purple indicator lights flashing</b>	High temperature alarm. Unit shutdown due to over heating: unplug and allow to cool for 10 minutes before resuming.

When a consumer buys a product in the UK, they get the benefit of legal rights relating to the quality of the product (your "legal rights"). You can enforce your legal rights against your retailer, including Shark if you bought your Shark appliance from [sharkclean.co.uk](http://sharkclean.co.uk). However, at Shark we are so confident about the quality of our products that we give the owner an additional, free parts and labour manufacturer's guarantee of up to 5 years. A household appliance like a Shark floorcare appliance constitutes a sizeable investment. Your new machine needs to work properly for as long as possible. The guarantee it comes with is an important consideration - and reflects how much confidence the manufacturer has in its product and manufacturing quality. The manufacturer's guarantee does not affect your legal rights.

#### How long are new Shark machines guaranteed for?

Our manufacturer's guarantee lasts for one year from the date of purchase as standard, or for five years if you register your purchase with us within 28 days. There is information on how to register below.

#### How do I register my Shark guarantee?

If you have purchased your Shark appliance directly from [sharkclean.co.uk](http://sharkclean.co.uk) your guarantee is registered automatically. If you bought it from anywhere else, you can register your guarantee online within 28 days of purchase.

- To register online, please visit [www.sharkclean.co.uk/register-guarantee](http://www.sharkclean.co.uk/register-guarantee) or scan the QR code in your instruction manual.
- Keep a note of the date you purchased the machine.

#### IMPORTANT:

- Keep your receipt if you bought your Shark floorcare appliance from anywhere except [sharkclean.co.uk](http://sharkclean.co.uk). You will need it to claim under your guarantee.
- The free Shark guarantee only applies to Shark owners living permanently in the UK.

#### What are the benefits of registering my free Shark guarantee?

When you register your guarantee, you will get an extra four years of cover. We'll also have your details to hand if we ever need to get in touch. If you further agree to receive communications from us, you can also receive tips and advice on how to get the best out of your Shark floorcare appliance and hear the latest news about new Shark technology and launches.

#### What is covered by the free Shark guarantee?

Repair or replacement (at Shark's option) of your Shark machine, including all parts and labour.

#### What is not covered by the free Shark guarantee?

- Normal wear and tear.
- Accidental damage or faults caused by negligent use or care, misuse, neglect, careless operation, or handling of the Shark appliance which is not in accordance with the Shark Operating Manual supplied with your machine.
- Damage caused by use of the Shark appliance for anything other than normal domestic household purposes.
- Damage caused by use of parts not assembled or installed in accordance with the operating instructions.
- Damage caused by use of parts and accessories which are not Shark Genuine Components
- Faulty installation (except where installed by Shark).
- Repairs or alterations carried out by parties other than Shark or its agents.

#### How can I claim under the free Shark guarantee?

Contact our customer service helpline on **0800 862 0453**. For service hours please visit our website under 'Contact Us'. It's free to call, and you'll be put straight through to a Shark representative. You'll also find online support at <https://support.sharkclean.co.uk>. The Shark representative will go through some troubleshooting with you, and if we conclude that the item has failed, we will send you a replacement part or a returns label to send the defective item back to us free of charge. When you have delivered the defective product to us, we will send you a replacement.

Please remember that the item will need to be boxed when you return it to us, which can be any suitable box; it does not have to be the original packaging.

#### Where can I buy genuine Shark spares and accessories?

Shark spares and accessories are developed by the same engineers who developed your Shark floorcare appliance. You'll find a full range of Shark spares, replacement parts and accessories for all Shark machines at [www.sharkclean.co.uk](http://www.sharkclean.co.uk). Please remember that damage caused by the use of non-Shark spares may not be covered under your guarantee.





**PLEASE READ CAREFULLY AND KEEP FOR FUTURE REFERENCE.**

This Instruction Booklet is designed to help you get a complete understanding of your new Shark® carpet cleaner.

**SharkNinja Europe Limited,  
1st/2nd Floor Building 3150,  
Thorpe Park, Century Way,  
Leeds,  
England,  
LS15 8ZB**

**[www.sharkclean.co.uk](http://www.sharkclean.co.uk)**

**SharkNinja Germany GmbH,  
Rotfeder-Ring 9,  
60327 Frankfurt am Main,  
Germany  
[www.sharkclean.eu](http://www.sharkclean.eu)**

Illustrations may differ from actual product. We are constantly striving to improve our products; therefore the specifications contained herein are subject to change without notice.

© 2024 SharkNinja Operating LLC.

SHARK is a registered trademark in the United Kingdom of SharkNinja Operating LLC.

CARPETXPRT is an unregistered trademark in the United Kingdom of SharkNinja Ltd Operating LLC.