

MAINTENANCE

Empty dust cup after each use

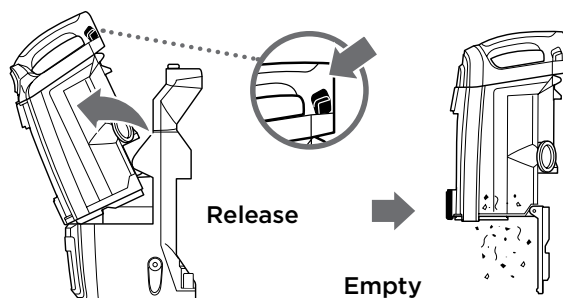

TIP:

Wash filters to keep the suction strong. Rinse filters and allow to air-dry completely. Tap loose dirt from foam filters as needed between washes. See enclosed instructions for complete details on removing and cleaning filters.

Access brushroll and Soft Roller

1. Use a coin to unlock the 3 locks on the bottom of the floor nozzle, a portion of the base is removable to allow for better access to the brush roll and exposure to the airway. Shine a torch from the bottom to check for possible blockage in the airway.
2. Clear away any objects or debris.
3. To reassemble, replace base by lining it up along the front of the nozzle. Push down to snap into place. Lock the 3 locks. If Brushroll Indicator Light isn't green and headlights are flashing, check again that both sides of lid are locked in place.

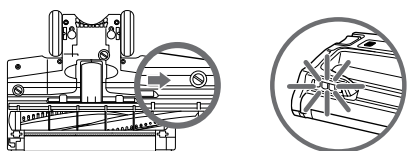

Brushroll Maintenance

Carefully remove any debris that may be impeding the brushroll.

Soft Roller Maintenance

Lift out the Soft Roller by pulling the tab on the right side. Clear away any debris, then slide the Soft Roller back into place.

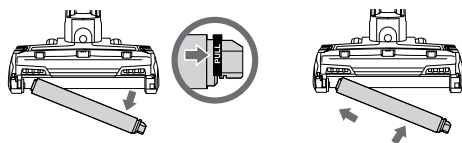

Checking the Nozzle for Blockages

Tilt neck of nozzle back to straighten the airway, then remove any blockages.

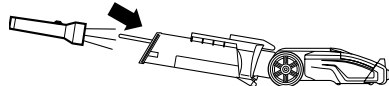

Shark

For questions or to register your product, contact us at
0800 862 0453 or visit us online at sharkclean.eu

 @sharkcleaninguk

 @sharkcleanuk

 @sharkcleanuk

©2019 SharkNinja Operating LLC. All rights reserved. Made in China. SHARK, DUOCLEAN and LIFT-AWAY are registered trademarks of SharkNinja Operating LLC. POWERED LIFT-AWAY is a trademark of SharkNinja Operating LLC. AZ910UKSeries_MP_QSG_190510_MV2

Please be sure to read the enclosed Shark instructions prior to using your vacuum

duo clean

ANTI HAIR
WRAP

Shark

DUOCLEAN®
POWERED LIFT-AWAY™ WITH
ANTI HAIR WRAP TECHNOLOGY

QUICK START GUIDE

Use this Quick Start Guide to start using your new vacuum's great features.

Register your vacuum at
registryyourshark.com

AZ910UK SERIES



WHAT'S INSIDE:

- A Handle
- B Hose
- C Vacuum Pod
- D Wand
- E DuoClean® Floor Nozzle
- F Duster Crevice Tool
- G Upholstery Tool
- H Pet Power Brush (certain models only)

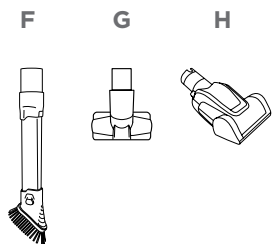

ASSEMBLY

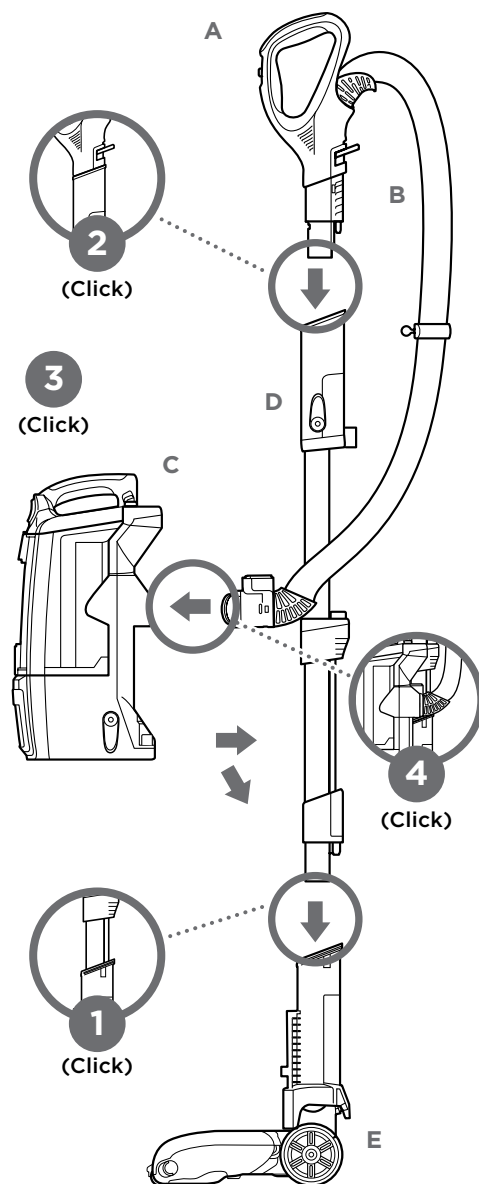

1. Insert wand into floor nozzle.
2. Insert handle into wand.
3. Place pod onto wand.
Slide down to connect.
4. Press hose into back of pod.

The top flap of your box shows the select accessories that are included with your model.
For complete instructions, see the enclosed instruction booklet.
For additional parts and accessories, visit sharkclean.eu

VERSATILE FLOOR-TO-CEILING CLEANING

UPRIGHT MODE

Place your foot gently on the floor nozzle and tilt the handle back. Choose floor type and press power button.



Floor Type

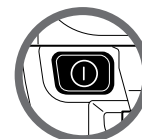

Power Button

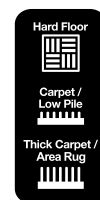
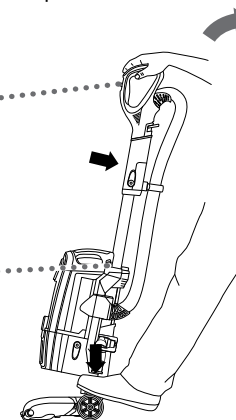

Hard Floor: Gentle on hard floors.

Carpet / Low Pile: Optimised brushroll speed and suction for carpets.

Thick Carpet / Area Rug: Optimised brushroll speed and suction for thick carpets.

POWERED LIFT-AWAY™ MODE

Press Lift-Away Release button to lift pod off wand to clean hard-to-reach places.



Lift-Away Release

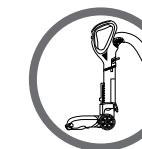

NOTE: See below for wand and handle release instructions.

ABOVE-FLOOR CLEANING IN LIFT-AWAY® MODE

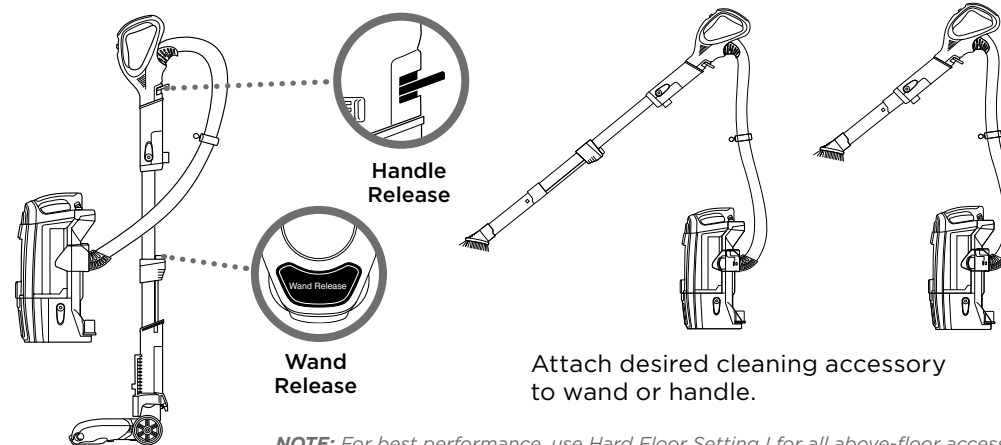

Attach desired cleaning accessory to wand or handle.

NOTE: For best performance, use Hard Floor Setting I for all above-floor accessories.